



WEKOS

L'anima del fuoco



cucine . cookers . cuisinières à bois . cocinas







“Non vi è fuoco simile alla passione d’amore”

Wekos domina il fuoco con passione, semplicità e creatività per realizzare stufe e cucine che hanno un’anima. Con un lavoro artigianale guidato dalla cura per il dettaglio e dall’amore per il bello, vengono realizzati modelli che dialogano tra tradizione e innovazione e che rappresentano il frutto di una continua ricerca sospesa tra design e funzionalità.

Entrare nelle case, con discrezione e carattere, proponendo elementi d’arredo che espletino le loro funzioni con efficacia, nel rispetto per la natura e che personalizzino il vostro ambiente senza invadenza perché lì i protagonisti siete voi: un obiettivo ambizioso, da raggiungere anche con esperienza.

“There is no fire like passion of love”

Wekos rules over fire with passion and simplicity creating stoves and cookers with a soul.

Ours is an artisan work led by our eye for detail and our love for beauty; our creations combine tradition with innovation and are the result of our continuous commitment in research on both design and functionality.

To enter your world with discretion and yet with character, with furniture pieces that perform their duty efficiently, in the respect for nature; they characterize and blend perfectly into your spaces where you are the protagonist: this is our goal, which we ambitiously aim at achieving strong with our experience.

“Il n’est pas de feu égal à la passion amoureuse”

Wekos domine le feu avec passion, simplicité et créativité pour réaliser des poêles à bois et des cuisinières à bois qui ont une âme. Par un travail artisanal guidé par le soin du détail et l’amour du beau, nous réalisons des modèles qui dialoguent entre tradition et innovation et qui représentent le fruit d’une recherche continue suspendue entre design et performances.

Entrer au cœur des maisons, avec discrétion et caractère, en proposant des éléments décoratifs qui jouent leur rôle avec efficacité, dans le respect de la nature et qui personnalisent votre intérieur sans être envahissants, parce que les protagonistes, c’est vous : un objectif ambitieux, que seule l’expérience permet d’atteindre.

“No hay fuego que se asemeja a la pasión del amor”

Wekos domina el fuego con pasión, simplicidad y creatividad para crear estufas y cocinas que tienen un alma. Con un trabajo artesanal guiado por el cuidado del detalle y por el amor a la belleza, se realizan modelos que dialogan entre tradición e innovación y que representan el fruto de una búsqueda continua con un pie en el diseño y otro en la funcionalidad. Entrar en las casas, con discreción y carácter, proponiendo elementos de decoración que desempeñen sus funciones con eficacia respetando la naturaleza y que personalicen su ambiente sin invadir, porque allí los protagonistas son ustedes: un objetivo ambicioso que, para alcanzarse, también requiere experiencia.

SOMMARIO

SUMMARY / INDEX / ÍNDICE

Cucine e termocucine - Cookers and thermo-cookers

Cuisinières et cuisinières bouilleurs - Cocinas y termo cocinas

Combinate 8

Classic 20

Monte Rosa 36

Moderne 42

Family Life 46

Fornelli 52

Cooking appliances - Fourneaux - Braseros

Barbecue 60

Accessori e Rivestimenti 64

Accessories and Coverings - Accessoires et Revêtements

Accesorios y Revestimientos



Tutti i prodotti WEKOS sono certificati secondo le norme

All WEKOS products are Mark-approved

Tous les produits WEKOS sont certifiés selon les normes

Todos los productos WEKOS están certificados según las normas

EN 12815:2001/A1:2004

(per cucine e termocucine) / (for cookers and thermo-cookers) / (pour cuisinières et cuisinières bouilleurs) / (para cocinas y termo cocinas)

Le caldaie delle termo cucine WEKOS sono costruite in acciaio inox 304. GARANZIA 10 ANNI. La garanzia decade nel caso di una non corretta installazione senza i dovuti sistemi di sicurezza. Il kit di installazione non è incluso.

ATTENZIONE! Non si possono utilizzare gli apparecchi termo senza il circolo dell'acqua all'interno della caldaia.

The boilers used for WEKOS thermo-cookers are made of stainless steel 304. 10 YEAR WARRANTY. Incorrect installation or failure to use appropriate safety systems shall render the warranty null and void. The installation kit is not included.

N.B.! Thermo-cookers cannot be used without water circulating in the boiler.

Les chaudières des cuisinières bouilleurs WEKOS sont construites en acier inox 304. GARANTIE 10 ANS. La garantie devient caduque en cas d'installation incorrecte sans les systèmes de sécurité obligatoires. Le kit d'installation n'est pas compris.

ATTENTION! Les cuisinières bouilleurs ne peuvent pas être utilisées si l'eau ne circule pas à l'intérieur de la chaudière.

Las calderas de las termo cocinas WEKOS están fabricadas en acero inoxidable 304. GARANTÍA 10 AÑOS. La garantía caduca en caso de instalación incorrecta sin los debidos sistemas de seguridad. No se incluye el kit de instalación.

¡ATENCIÓN! Las termo cocinas no se pueden utilizar sin la circulación de agua en el interior de la caldera.

LEGENDA

LEGEND / LÉGENDE / LEYENDA

- Cucina - Cooker
Cuisinière - Cocina
- Termocucina - Thermo-cooker
Cuisinière bouilleur - Termo cocina
- Peso netto - Net weight
Poids net - Peso Neto
- Potenza nominale (utile) - Nominal heat output
Puissance nominale (utile) - Potencia nominal (útil)
 m^2 = (m² riscaldabili - m² that can be heated - m² maximum chauffée - m² calefaccionables)
 m^3 = (m³ riscaldabili - m³ that can be heated - m³ maximum chauffée - m³ calefaccionables)
- Potenza resa all'acqua - Water heat output
Puissance rendue à l'eau - Potencia rendimiento al agua
- Potenza resa all'ambiente - Space heat output
Puissance rendue à la pièce - Potencia rendimiento al ambiente
- Scarico fumi - Flue
Evacuation fumées - Descarga humos
- Depressione media al camino - Flue draft pressure
Dépression moyenne à la cheminée - Depresión media en la chimenea
- Rendimento - Efficiency
Rendement - Rendimiento
- Massima pressione d'esercizio - Maximum working pressure
Pression maximum de fonctionnement - Máxima presión de trabajo
- Caldaia Acciaio Inox 304 - Boiler Stainless steel 304
Chaudière acier inox 304 - Caldera acero inox 304
- Installazione a Vaso Aperto o a Vaso Chiuso - Suitable for installation with open or closed expansion tank - Installation à vase d'expansion ouvert ou à vase d'expansion fermé - con vaso de expansion abierto o cerrado.
- Focolare / Spazio utile focolare - Hearth / Useable space hearth
Foyer / Espace utile foyer - Hogar / Espacio útil hogar
- Rivestimenti - Coverings
Revêtements - Revestimientos
- Pannelli verniciati - Painted panels
Panneaux peints - Paneles pintados
- Pannelli smaltati - Enamelled panels
Panneaux emailles - Paneles esmaltados
- Piastrelle - Tiles
Carreaux - Azulejos
- Scarico fumi posteriore - Rear flue
Evacuation fumées postérieure - Descarga de humos posterior
- Forno elettrico multifunzione - Multipurpose electric oven
Multifonction électrique four - Horno eléctrico multifunción
- Spazio utile forno a legna - Useable space oven
Espace utile four à bois - Espacio útil horno a leña
- Spazio utile porta legna - Useable space log stacker
Espace utile tiroir coulissant - Espacio util porta lena





combinate



120 LGE RUSTICA



Con fianchi piastrellati e piedi, finiture inox. Piano cottura: 4 fuochi. Versione ad incasso con zoccolo H 85/90 cm.

With tiled sides and feet, stainless steel finishes. Cooktop: 4 burners. Built-in version with base H 85/90 cm.

Avec flancs carrelés et pieds, finitions inox. Plan de cuisson: 4 feux. Version encastrable avec socle H 85/90 cm.

Con lados azulejados y pies, acabados inox. Placa de cocción: 4 fuegos. Versión empotrable con zócalo A 85/90 cm.

								η		VAC					OPTIONAL	OPTIONAL SX
 C 036	287 kg	9 kW 7.740 kcal/h 65 m ² 176 m ³	-	-	14 Ø cm	12 Pa	-	72,5 %	-	-	refrattario refractory réfractaire refractorio 6 cm sp. - thk. ép. - esp. 26 cm 35 cm 40 cm	 8x8	-	2,7 kW 30 cm 40 cm 45 cm	✓	
 TC 024	306 kg	19 kW 16.340 kcal/h 137 m ² 370 m ³	12 kW	7 kW	14 Ø cm	12 Pa	2 bar	76 %	30/10 sp. - thk. ép. - esp. 28 Lt	✓	26 cm 37 cm 42 cm	 8x8	-	2,7 kW 30 cm 40 cm 45 cm	✗	

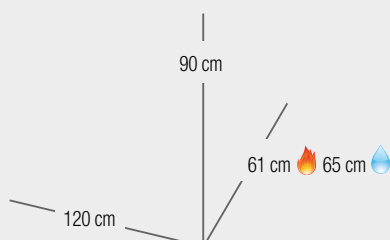

vista sopra
top view
vue de dessus
vista superior

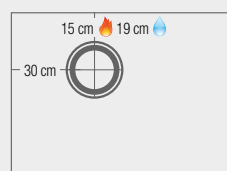

vista frontale retro
rear view
vue de derrière
vista delantera y trasera

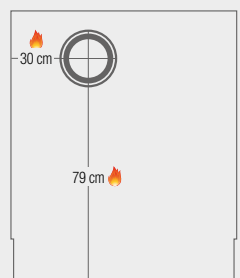

120 LGE/F INOX "LOBELIA"



Con fianchi piastrellati, piedi e forno a legna. Piano cottura: 4 fuochi.

With tiled sides, feet and wood oven. Cooktop: 4 burners.

Avec flancs carrelés, pieds et four à bois. Plan de cuisson: 4 feux.

Con lados azulejados, pies y horno de leña. Placa de cocción: 4 fuegos.

									VAC					OPTIONAL	OPTIONAL SX	
 C 090	284 kg	7,56 kW 6.502 kcal/h 54 m ² 146 m ³	-	-	14 Ø cm	12 Pa	-	76,24 %	-	-	refrattario refractory réfractaire refractorio 3 cm sp. - thk. ép. - esp. 19 cm 35 cm 40 cm	 8x8	 37 cm 19 cm 41 cm	 2,7 kW 30 cm 40 cm 45 cm		

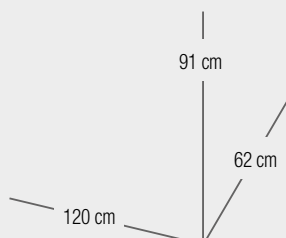

vista sopra
top view
vue de dessus
vista superior

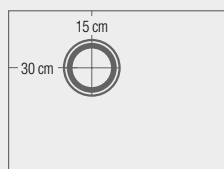

vista frontale retro
rear view
vue de derrière
vista delantera y trasera

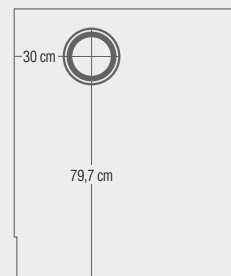

135 LGE RUSTICA "ARNICA"



Con fianchi piastrellati, piedi, forno a legna, finiture inox. Piano cottura: 5 fuochi.

With tiled sides and feet, wood burning oven, stainless steel finishes. Cooktop: 5 burners.

Avec flancs carrelés, pieds, four à bois et finitions inox. Plan de cuisson: 5 feux.

Con lados azulejados y pies, horno a leña, acabados inox. Placa de cocción: 5 fuegos.

	315 kg	7,56 kW 6.502 kcal/h 54 m ² 146 m ³	-	-	14 Ø cm	12 Pa	-	76,24 %	-	-	refrattario refractory réfractaire refractorio 3 cm sp. - thk. ép. - esp. 19 cm 35 cm 40 cm	 8x8 19 cm 37 cm 41 cm	2,7 kW 30 cm 50 cm 45 cm		

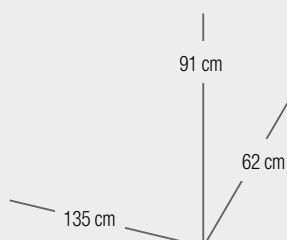

vista sopra
top view
vue de dessus
vista superior

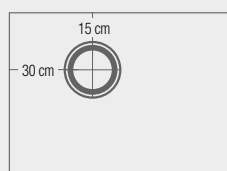

vista frontale retro
rear view
vue de derrière
vista delantera y trasera

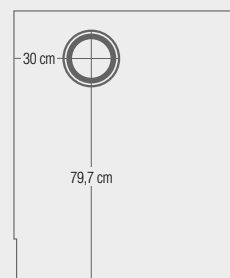

135 LGE/SF INOX "ARNICA" SX



Con fianchi smaltati, piedi e forno a legna. Piano cottura: 5 fuochi.

With enamelled sides, feet and wood burning oven. Cooktop: 5 burners.

Avec flancs émaillés, pieds et four à bois. Plan de cuisson: 5 feux.

Con lados esmaltados, pies y horno a leña. Placa de cocción: 5 fuegos.

									VAC					OPTIONAL	OPTIONAL SX
CSF 107	297 kg	7,56 kW 6.502 kcal/h 54 m ² 146 m ³	-	-	14 Ø cm	12 Pa	-	76,24 %	-	refrattario refractory réfractaire refractorio 3 cm sp. - thk. ép. - esp. 19 cm 35 cm 40 cm	 8x8	 19 cm 37 cm 41 cm	 2,7 kW 30 cm 50 cm 45 cm		

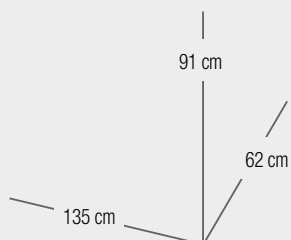

vista sopra
top view
vue de dessus
vista superior



vista frontale retro
rear view
vue de derrière
vista delantera y trasera

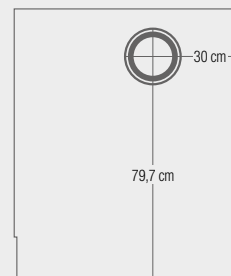

135 LGE INOX "VIOLETTA"



Con fianchi piastrellati e piedi.
Piano cottura: 5 fuochi.

With tiled sides and feet.
Cooktop: 5 burners.

Avec flancs carrelés et pieds.
Plan de cuisson: 5 feux.

Con lados azulejados y pies.
Placa de cocción: 5 fuegos.

								η		VAC					OPTIONAL	OPTIONAL SX
 C 115	302 kg	9 kW 7.740 kcal/h 65 m ² 176 m ³	-	-	14 Ø cm	12 Pa	-	72,5 %	-	-	refrattario refractory réfractaire refractorio 6 cm sp. - thk ép. - esp. 26 cm 35 cm 40 cm	 8x8	-	2,7 kW 30 cm 50 cm 45 cm	✓	
 TC 112	302 kg	19 kW 16.340 kcal/h 137 m ² 370 m ³	12 kW	7 kW	14 Ø cm	12 Pa	2 bar	76 %	30/10 sp. - thk ép. - esp. 28 Lt	✓	26 cm 37 cm 44 cm	 8x8	-	2,7 kW 30 cm 50 cm 45 cm	✗	

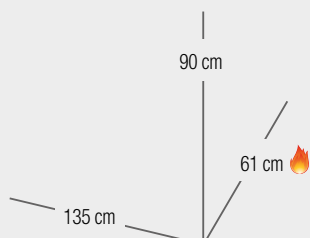

vista sopra
top view
vue de dessus
vista superior

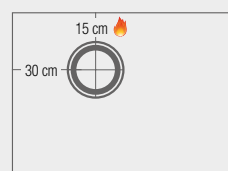

vista frontale retro
rear view
vue de derrière
vista delantera y trasera

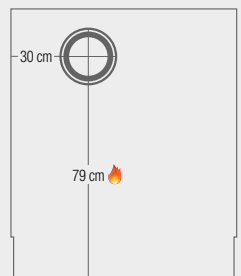

360 LGE/SF INOX



**Con fianchi smaltati e piedi.
Piano cottura: 4 fuochi.**

With enamelled sides and feet.
Cooktop: 4 burners.

Avec flancs émaillés et pieds.
Plan de cuisson: 4 feux.

Con lados esmaltados y pies.
Placa de cocción: 4 fuegos.

								η		VAC					OPTIONAL	OPTIONAL SX
 CSF 038	316 kg	11,5 kW 9.890 kcal/h 80 m ² 217 m ³	-	-	14 Ø cm	12 Pa	-	77,7 %	-	-	refrattario refractory réfractaire refractorio 6 cm sp. - thk. ép. - esp. 26 cm 22 cm 51 cm	 8x8	26 cm 38 cm 42 cm	2,7 kW 30 cm 40 cm 45 cm		
 TCSF 022	298 kg	17,5 kW 15.050 kcal/h 127 m ² 343 m ³	9,5 kW	8 kW	14 Ø cm	12 Pa	2 bar	78,8 %	30/10 sp. - thk. ép. - esp. 20 Lt		26 cm 28 cm 52 cm	 8x8	26 cm 38 cm 42 cm	2,7 kW 30 cm 40 cm 45 cm		

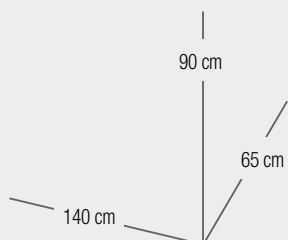

vista sopra
top view
vue de dessus
vista superior

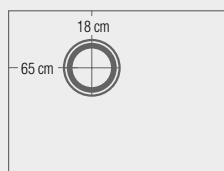

vista frontale retro
rear view
vue de derrière
vista delantera y trasera

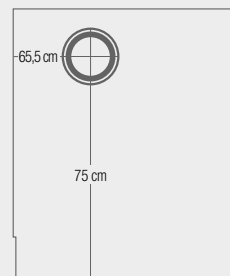

360 LGE RUSTICA



Con fianchi piastrellati e piedi, finiture ottone. Piano cottura: 4 fuochi.

With tiled sides and feet, brass finished. Cooktop: 4 burners.

Avec flancs carrelés et pieds, finitions laiton. Plan de cuisson: 4 feux.

Con lados azulejados y pies, acabados en latón. Placa de cocción: 4 fuegos.

								η		VAC					OPTIONAL	OPTIONAL SX
 C 017	338 kg	11,5 kW 9.890 kcal/h 80 m ² 217 m ³	-	-	14 Ø cm	12 Pa	-	77,7 %	-	-	refrattario refractory réfractaire refractorio 6 cm sp. - thk. ép. - esp. 26 cm 22 cm 51 cm	 8x8	26 cm 38 cm 42 cm	2,7 kW 30 cm 45 cm 40 cm	✓	
 TC 010	313 kg	17,5 kW 15.050 kcal/h 127 m ² 343 m ³	9,5 kW	8 kW	14 Ø cm	12 Pa	2 bar	78,8 %	30/10 sp. - thk. ép. - esp. 20 Lt	✓	26 cm 28 cm 52 cm	 8x8	26 cm 38 cm 42 cm	2,7 kW 30 cm 45 cm 40 cm	✓	

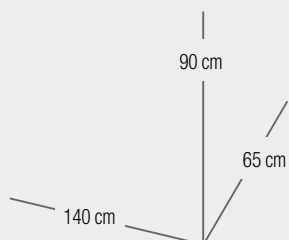

vista sopra
top view
vue de dessus
vista superior

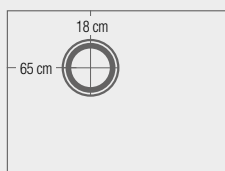

vista frontale retro
rear view
vue de derrière
vista delantera y trasera

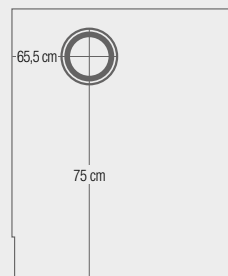

360 LGE INOX



Con fianchi piastrellati e piedi, porte tutto vetro. Rivestimento piastrelle vintage. Piano cottura: 4 fuochi.

With tiled sides and feet, all-glass doors. Vintage tile covering. Cooktop: 4 burners.

Avec flancs carrelés et pieds, portes entièrement vitrées. Revêtement carreaux vintage. Plan de cuisson: 4 feux.

Con lados azulejados, pies y puertas de vidrio. Revestimiento de azulejos vintage. Placa de cocción: 4 fuegos.

								η		VAC					OPTIONAL	OPTIONAL SX
 C 018	326 kg	11,5 kW 9.890 kcal/h 80 m ² 217 m ³	-	-	14 Ø cm	12 Pa	-	77,7 %	-	-	refrattario refractory réfractaire refractorio 6 cm sp. - thk. ép. - esp. 26 cm 22 cm 51 cm	 8x8	 26 cm 38 cm 42 cm	 2,7 kW 30 cm 40 cm 45 cm		
 TC 011	313 kg	17,5 kW 15.050 kcal/h 127 m ² 343 m ³	9,5 kW	8 kW	14 Ø cm	12 Pa	2 bar	78,8 %	30/10 sp. - thk. ép. - esp. 20 Lt		26 cm 28 cm 52 cm	 8x8	 26 cm 38 cm 42 cm	 2,7 kW 30 cm 40 cm 45 cm		

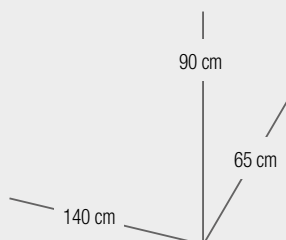

vista sopra
top view
vue de dessus
vista superior

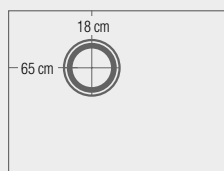

vista frontale retro
rear view
vue de derrière
vista delantera y trasera

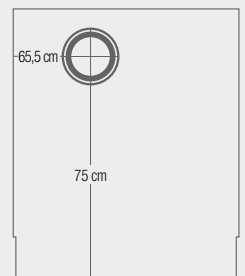

165 LGE/SF RUSTICA "SANTOREGGIA"



Con fianchi smaltati, piedi, finiture
ottone. Piano cottura: 5 fuochi.

With enamelled sides, feet, brass finishes.
Cooktop: 5 burners.

Avec flancs émaillés, pieds, finitions laiton.
Plan de cuisson: 5 feux.

Con lados esmaltados, pies, acabados en
latón. Placa de cocción: 5 fuegos.

								η		VAC					OPTIONAL	OPTIONAL SX
 CSF 098	354 kg	11,5 kW 9.890 kcal/h 80 m ² 217 m ³	-	-	14 Ø cm	12 Pa	-	77,7 %	-	-	refrattario refractory réfractaire refractorio 6 cm sp. - thk. ép. - esp. 26 cm 22 cm 51 cm	 8x8	26 cm 38 cm 42 cm	2,7 kW 30 cm 50 cm 45 cm	✓	
 TCSF 098	347 kg	17,5 kW 15.050 kcal/h 127 m ² 343 m ³	9,5 kW	8 kW	14 Ø cm	12 Pa	2 bar	78,8 %	30/10 sp. - thk. ép. - esp. 20 Lt	✓	26 cm 28 cm 52 cm	 8x8	26 cm 38 cm 42 cm	2,7 kW 30 cm 50 cm 45 cm	✓	

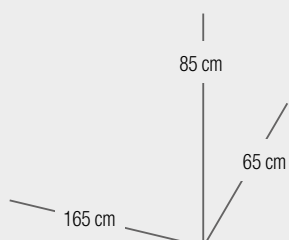

vista sopra
top view
vue de dessus
vista superior

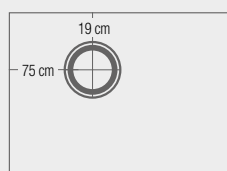

vista frontale retro
rear view
vue de derrière
vista delantera y trasera

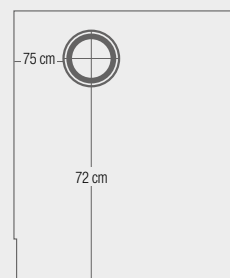

180 LGE INOX "GENZIANA"



Con fianchi piastrellati, piedi, porta focolare e porta forno con vetro. Piano cottura: 5 fuochi.

With tiled sides, feet, hearth door and oven door with glass. Cooktop: 5 burners.

Avec flancs carrelés, pieds, porte foyer et porte four avec vitre. Plan de cuisson: 5 feux.

Con lados azulejados, pies, puerta del hogar y puerta del horno con vidrio. Placa de cocción: 5 fuegos.

								η		VAC					OPTIONAL	OPTIONAL SX
 C 046	380 kg	11,5 kW 9.890 kcal/h 80 m ² 217 m ³	-	-	14 Ø cm	12 Pa	-	77,7 %	-	-	refrattario refractory réfractaire refractorio 6 cm sp. - thk. ép. - esp. 26 cm 22 cm 51 cm	 8x8	26 cm 38 cm 42 cm	2,7 kW 30 cm 60 cm 45 cm		
 TC 046	352 kg	17,5 kW 15.050 kcal/h 127 m ² 343 m ³	9,5 kW	8 kW	14 Ø cm	12 Pa	2 bar	78,8 %	30/10 sp. - thk. ép. - esp. 20 Lt		26 cm 28 cm 52 cm	 8x8	26 cm 38 cm 42 cm	2,7 kW 30 cm 60 cm 45 cm		

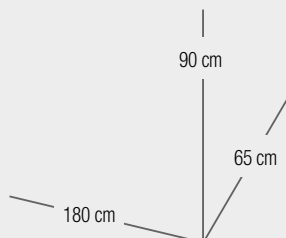

vista sopra
top view
vue de dessus
vista superior

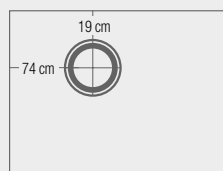

vista frontale retro
rear view
vue de derrière
vista delantera y trasera

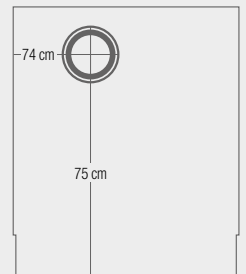





classic



601/IS RUSTICA



Ad incasso con finiture ottone.
Versione con piedi H 90 cm.

Built-in, brass finishes.
Version with feet H 90 cm.

A encastrement avec finition laiton.
Version avec pieds H 90 cm.

Empotrables con acabados en latón.
Versión con pies A 90 cm.

								η		VAC					OPTIONAL	OPTIONAL SX
 CS 013	167 kg	9 kW 7.740 kcal/h 65 m ² 176 m ³	-	-	14 Ø cm	12 Pa	-	72,5 %	-	-	refrattario refractory réfractaire refractorio 6 cm sp. - thk. ép. - esp. 26 cm 35 cm 40 cm	 8x8	-	-	✓	-
 TCS 001	183 kg	19 kW 16.340 kcal/h 137 m ² 370 m ³	12 kW	7 kW	14 Ø cm	12 Pa	2 bar	76 %	30/10 sp. - thk. ép. - esp. 28 Lt	✓	26 cm 37 cm 42 cm	 8x8	-	-	✗	-

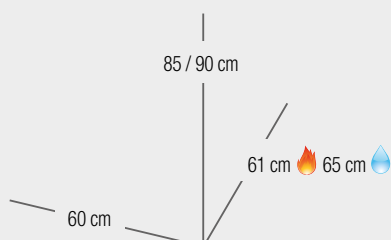

vista sopra
top view
vue de dessus
vista superior

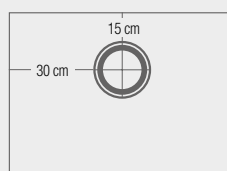

vista frontale retro
rear view
vue de derrière
vista delantera y trasera

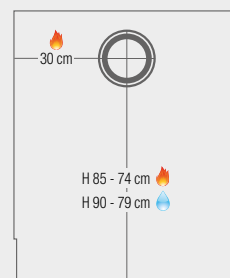

601 CON FORNO RUSTICA "SERENELLA"



Con fianchi piastrellati, piedi e forno a legna, finiture inox. Versione ad incasso con zoccolo H 90 cm.

With tiled sides, feet and wood oven, stainless steel finishes. Built-in version with base H 90 cm.

Avec flancs carrelés, pieds et four à bois, finitions inox. Version encastrable avec socle H 90 cm.

Con lados azulejados, pies y horno de leña, acabados inox. Versión empotrable con zócalo A 90 cm.

								η		VAC					OPTIONAL	OPTIONAL SX
 C 083	186 kg	7,56 kW 6.502 kcal/h 54 m ² 146 m ³	-	-	14 Ø cm	12 Pa	-	76,24 %	-	-	refrattario refractory réfractaire refractorio 3 cm sp. - thk. ép. - esp. 19 cm 35 cm 40 cm	 8x8	19 cm 37 cm 41 cm	-	✓	-

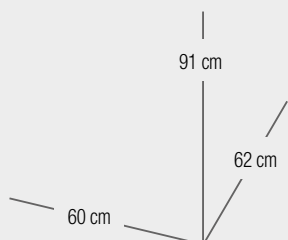

vista sopra
top view
vue de dessus
vista superior

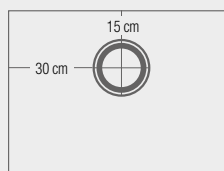

vista frontale retro
rear view
vue de derrière
vista delantera y trasera

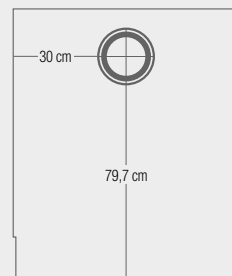

70 E RUSTICA



Con fianchi piastrellati,
piedi e finiture inox.

With tiled sides, feet
and stainless steel finishes.

Avec flancs carrelés, pieds
et finitions inox.

Con lados azulejados, pies
y acabados inox.

								η		VAC					OPTIONAL 	OPTIONAL SX
 C 040	166 kg	8,34 kW 7.172 kcal/h 60 m ² 162 m ³	-	-	14 Ø cm	12 Pa	-	73,6 %	-	-	refrattario refractory réfractaire refractorio 3/5 cm sp. - thk. ép. - esp. 26 cm 22 cm 40 cm	 10x10	26 cm 22 cm 39 cm	-	✓	✗

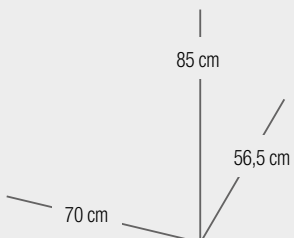

vista sopra
top view
vue de dessus
vista superior

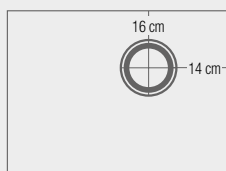

vista frontale retro
rear view
vue de derrière
vista delantera y trasera

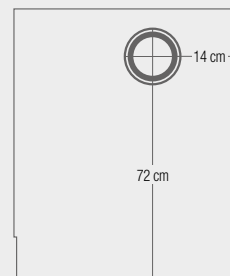

75 E RUSTICA "PERVINCA"



Con fianchi piastrellati,
piedi e finiture inox.

With Tiled sides and feet,
stainless steel finishes.

Avec flancs carrelés,
pieds et finitions inox.

Con lados azulejados,
pies y acabados inox.

								η		VAC					OPTIONAL 	OPTIONAL SX
 C 102	186 kg	8,5 kW 7.310 kcal/h 62 m ² 165 m ³	-	-	14 Ø cm	12 Pa	-	75 %	-	-	refrattario refractory réfractaire refractorio 3/5 cm sp. - thk. ép. - esp. 23 cm 22 cm 40 cm	 10x10	24 cm 28 cm 40 cm	-	✓	✗

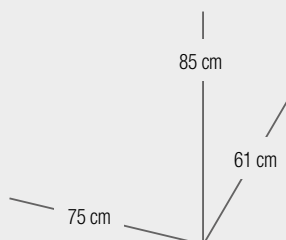

vista sopra
top view
vue de dessus
vista superior

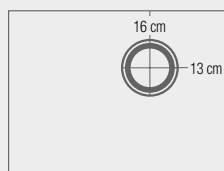

vista frontale retro
rear view
vue de derrière
vista delantera y trasera

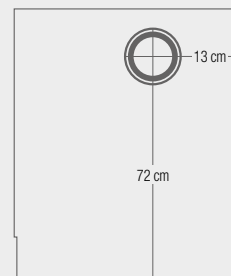

80 L/CIS RUSTICA CON CASSETTONE



Ad incasso, con cassettone e finiture inox.

Built-in, fitted with drawer and stainless steel finishes.

A encastrement, avec tiroir et finitions inox.

Empotrables, con cajón y acabados inox.

								η		VAC					OPTIONAL	OPTIONAL SX
 CS 004	186 kg	8,5 kW 7.310 kcal/h 62 m ² 165 m ³	-	-	14 Ø cm	12 Pa	-	75 %	-	-	refrattario refractory réfractaire refractorio 5 cm sp. - thk. ép. - esp. 23 cm 22 cm 40 cm	 8x8	24 cm 28 cm 40 cm	18,5 cm 69 cm 50 cm	✓	✗

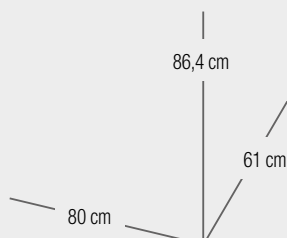

vista sopra
top view
vue de dessus
vista superior

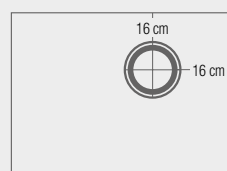

vista frontale retro
rear view
vue de derrière
vista delantera y trasera

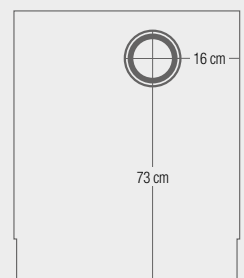

80 L/PI RUSTICA "VANIGLIA"



Ad incasso con piedi, porta focolare e porta forno con vetro, finiture ottone.

Built-in with feet, hearth door and oven door with glass, brass finishes.

A encastrement avec pieds, porte foyer et porte four avec vitre et finitions laiton.

Empotrables con Pies, porta hogar y porta horno con vidrio y acabado en latón.

								η		VAC					OPTIONAL	OPTIONAL SX
 C 053	171 kg	8,5 kW 7.310 kcal/h 62 m ² 165 m ³	-	-	14 Ø cm	12 Pa	-	75 %	-	-	refrattario refractory réfractaire refractorio 5 cm sp. - thk. ép. - esp. 23 cm 22 cm 40 cm	 8x8	24 cm 28 cm 40 cm	-	✓	✗

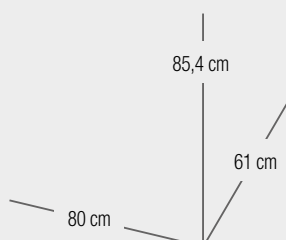

vista sopra
top view
vue de dessus
vista superior

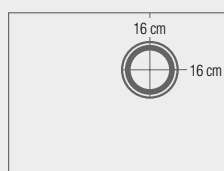

vista frontale retro
rear view
vue de derrière
vista delantera y trasera

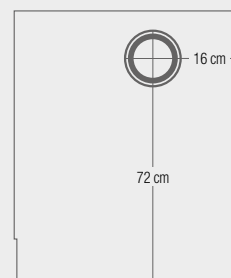

AMICA RUSTICA



Con fianchi smaltati e piedi, finiture ottone.

With enamelled sides and feet, brass finishes.

Avec flancs émaillés et pieds, finitions laiton.

Con lados esmaltados y pies, acabados en latón.

								η		VAC					OPTIONAL	OPTIONAL SX
 CSF 020	220 kg	8,5 kW 7.310 kcal/h 62 m ² 165 m ³	-	-	14 Ø cm	12 Pa	-	75 %	-	-	refrattario refractory réfractaire refractorio 5 cm sp. - thk. ép. - esp. 23 cm 22 cm 40 cm		24 cm 28 cm 40 cm	-	✓	
 TCSF 016	190 kg	15 kW 12.900 kcal/h 109 m ² 294 m ³	8 kW	7 kW	14 Ø cm	12 Pa	2 bar	78 %	30/10 sp. - thk. ép. - esp. 18 Lt	✓	23 cm 26 cm 51 cm		24 cm 28 cm 40 cm	-	✓	✗

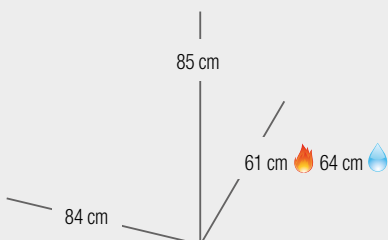

vista sopra
top view
vue de dessus
vista superior

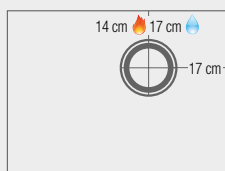

vista frontale retro
rear view
vue de derrière
vista delantera y trasera

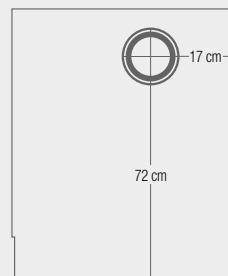

CLASSIC 85 RUSTICA



Con fianchi piastrellati e piedi - porta focolare e porta forno con vetro, finiture ottone.

With tiled sides and feet - hearth door and oven door with glass, brass finishes.

Avec flancs carrelés et pieds, porte foyer et porte four avec vitre, finitions laiton.

Con lados azulejados y pies, puerta hogar y puerta horno con vidrios, acabados en latón.

								η		VAC					OPTIONAL	OPTIONAL SX
 C 008	220 kg	8,5 kW 7.310 kcal/h 62 m ² 165 m ³	-	-	14 Ø cm	12 Pa	-	75 %	-	-	refrattario refractory réfractaire refractorio 5 cm sp. - thk. ép. - esp. 23 cm 22 cm 40 cm		24 cm 28 cm 40 cm	-	✓	
 TC 013	200 kg	15 kW 12.900 kcal/h 109 m ² 294 m ³	8 kW	7 kW	14 Ø cm	12 Pa	2 bar	78 %	30/10 sp. - thk. ép. - esp. 18 Lt	✓	23 cm 26 cm 51 cm		24 cm 28 cm 40 cm	-	✓	✗

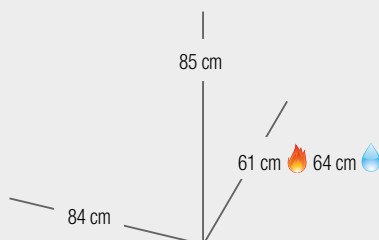

vista sopra
top view
vue de dessus
vista superior

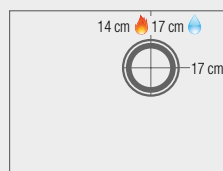

vista frontale retro
rear view
vue de derrière
vista delantera y trasera

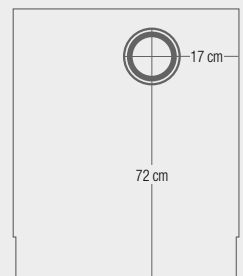

CLASSIC 90/SF RUSTICA



Con fianchi smaltati, piedi e finiture ottone.

With enamelled sides, feet and brass finishes.

Avec flancs émaillés, pieds et finitions laiton.

Con lados esmaltados, pies y acabados en latón.

								η		VAC					OPTIONAL	OPTIONAL SX
 CSF 028	248 kg	11,5 kW 9.890 kcal/h 80 m ² 217 m ³	-	-	14 Ø cm	12 Pa	-	77,7 %	-	-	refrattario refractory réfractaire refractorio 6 cm sp. - thk. ép. - esp. 26 cm 22 cm 51 cm	 8x8	26 cm 38 cm 42 cm	-	✓	
 TCSF 007	230 kg	17,5 kW 15.050 kcal/h 127 m ² 343 m ³	9,5 kW	8 kW	14 Ø cm	12 Pa	2 bar	78,8 %	30/10 sp. - thk. ép. - esp. 20 Lt	✓	26 cm 28 cm 52 cm	 8x8	26 cm 38 cm 42 cm	-	✓	

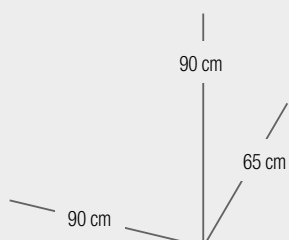

vista sopra
top view
vue de dessus
vista superior

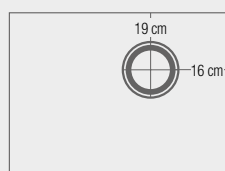

vista frontale retro
rear view
vue de derrière
vista delantera y trasera

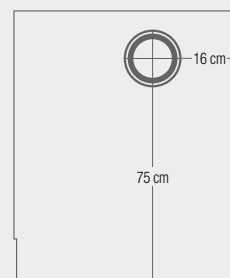

CLASSIC 90/SF INOX



Con fianchi smaltati, piedi e decoro fiori.

With enamelled sides, feet and flower fret design.

Avec flancs émaillés, pieds et décoration fleurs.

Con lados esmaltados, pies y decoración de flores.

								η		VAC					OPTIONAL	OPTIONAL SX
 CSF 029	245 kg	11,5 kW 9.890 kcal/h 80 m ² 217 m ³	-	-	14 Ø cm	12 Pa	-	77,7 %	-	-	refrattario refractory réfractaire refractorio 6 cm sp. - thk. ép. - esp. 26 cm 22 cm 51 cm	 8x8	26 cm 38 cm 42 cm	-	✓	
 TCSF 008	218 kg	17,5 kW 15.050 kcal/h 127 m ² 343 m ³	9,5 kW	8 kW	14 Ø cm	12 Pa	2 bar	78,8 %	30/10 sp. - thk. ép. - esp. 20 Lt	✓	26 cm 28 cm 52 cm	 8x8	26 cm 38 cm 42 cm	-	✓	

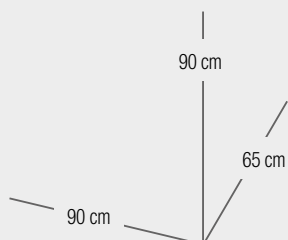

vista sopra
top view
vue de dessus
vista superior

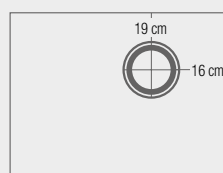

vista frontale retro
rear view
vue de derrière
vista delantera y trasera

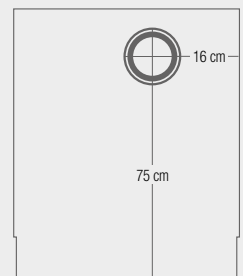

CLASSIC 90 INOX



Con fianchi piastrellati, piedi, porta focolare e porta forno con vetro, rivestimento piastrelle vintage.

With enamelled sides, feet, hearth door and oven door with glass, vintage tile covering.

Avec flancs carrelés, pieds, porte foyer et porte four avec vitre, revêtement carreaux vintage.

Con lados azulejados, pies, puerta del hogar y puerta del horno con vidrio y revestimiento con azulejos vintage.

								η		VAC					OPTIONAL	OPTIONAL SX
 C 012	249 kg	11,5 kW 9.890 kcal/h 80 m ² 217 m ³	-	-	14 Ø cm	12 Pa	-	77,7 %	-	-	refrattario refractory réfractaire refractorio 6 cm sp. - thk. ép. - esp. 26 cm 22 cm 51 cm	 8x8	26 cm 38 cm 42 cm	-	✓	
 TC 005	233 kg	17,5 kW 15.050 kcal/h 127 m ² 343 m ³	9,5 kW	8 kW	14 Ø cm	12 Pa	2 bar	78,8 %	30/10 sp. - thk. ép. - esp. 20 Lt	✓	26 cm 28 cm 52 cm	 8x8	26 cm 38 cm 42 cm	-	✓	

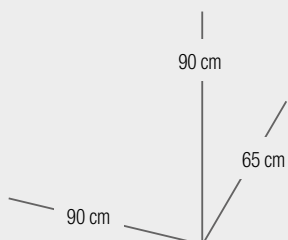

vista sopra
top view
vue de dessus
vista superior

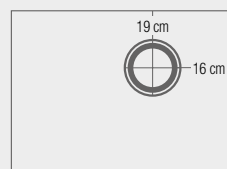

vista frontale retro
rear view
vue de derrière
vista delantera y trasera

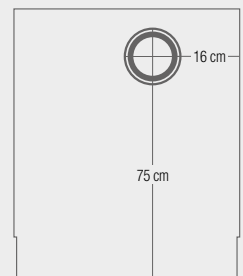

CLASSIC 100



Con fianchi piastrellati, piedi, porta focolare e porta forno con vetro, finiture inox.

With enamelled sides, feet, hearth door and oven door with glass, stainless steel finishes.

Avec flancs carrelés, pieds, porte foyer et porte four avec vitre, finitions inox.

Con lados azulejados, pies, puerta del hogar y puerta del horno con vidrio y acabados inox.

								η		VAC					OPTIONAL	OPTIONAL SX
 C 110	247 kg	13 kW 11.180 kcal/h 91 m ² 246 m ³	-	-	14 Ø cm	12 Pa	-	80 %	-	-	refrattario refractory réfractaire refractorio 5 cm sp. - thk. ép. - esp. 30 cm 29 cm 50 cm	 8x8	 30 cm 40 cm 42 cm	-		

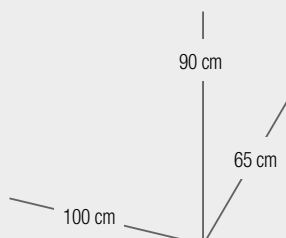

vista sopra
top view
vue de dessus
vista superior

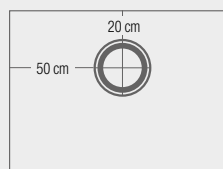

vista frontale retro
rear view
vue de derrière
vista delantera y trasera

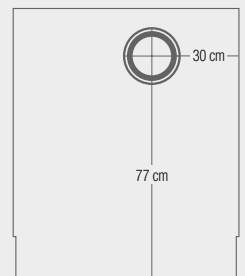

106 RUSTICA "VALERIANA"



Con fianchi piastrellati, piedi e finiture ottone.

With tiled sides, feet and brass finishes.

Avec flancs carrelés, pieds et finitions laiton.

Con lados azulejados, pies y acabados en latón.

								η		VAC					OPTIONAL	OPTIONAL SX
 C 048	299 kg	15 kW 12.900 kcal/h 108 m ² 292 m ³	-	-	14 Ø cm	12 Pa	-	81 %	-	-	refrattario refractory réfractaire refractorio 6 cm sp. - thk. ép. - esp. 26 cm 36 cm 50 cm	 8x8 26 cm 38 cm 42 cm	-	✓	✗	
 TC 048	264 kg	19 kW 16.340 kcal/h 137 m ² 370 m ³	11,8 kW	7,2 kW	14 Ø cm	12 Pa	2 bar	75,7 %	30/10 sp. - thk. ép. - esp. 28,5 Lt	✓	26 cm 38 cm 52 cm	 8x8 26 cm 38 cm 42 cm	-	✓	✗	

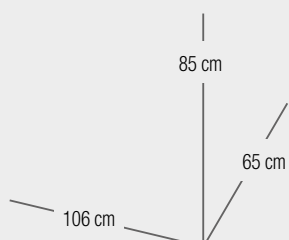

vista sopra
top view
vue de dessus
vista superior

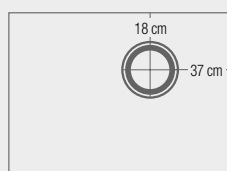

vista frontale retro
rear view
vue de derrière
vista delantera y trasera

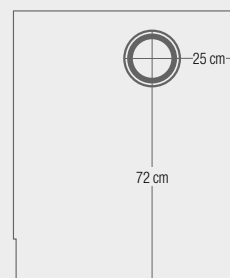







monte rosa



“MONTE ROSA 85”



Telai neri, profili rame e porta focolare e porta forno con vetro, rivestimento pietra serpentino.

Black door frames, copper trim, hearth door and oven door with glass, covering serpentine stone.

Châssis noirs, profils cuivre, porte foyer et porte four avec vitre, revêtement pierre serpentino.

Bastidores negros, perfiles en cobre, puerta hogar y puerta horno con vidrios, revestimiento piedra serpentino.

								η		VAC					OPTIONAL	OPTIONAL SX
 CRP 85	251 kg	8,5 kW 7.310 kcal/h 62 m ² 165 m ³	-	-	14 Ø cm	12 Pa	-	75 %	-	-	refrattario refractory réfractaire refractorio 5 cm sp. - thk. ép. - esp. 23 cm 22 cm 40 cm		24 cm 28 cm 40 cm	-	✓	
 TCRP 85	231 kg	15 kW 12.900 kcal/h 109 m ² 294 m ³	8 kW	7 kW	14 Ø cm	12 Pa	2 bar	78 %	30/10 sp. - thk. ép. - esp. 18 Lt	✓	23 cm 26 cm 51 cm		24 cm 28 cm 40 cm	-	✓	✗

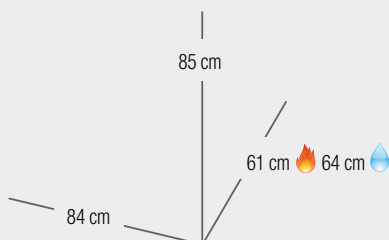

vista sopra
top view
vue de dessus
vista superior

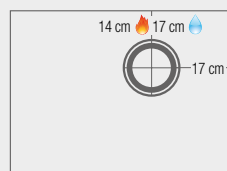

vista frontale retro
rear view
vue de derrière
vista delantera y trasera

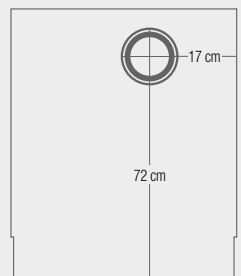

"MONTE ROSA 90"



Telai neri, profili rame, porta focolare e porta forno con vetro, rivestimento pietra serpentino.

Black door frames, copper trim, hearth door and oven door with glass, covering serpentine stone.

Châssis noirs, profils cuivre, porte foyer et porte four avec vitre, revêtement pierre serpentino.

Bastidores negros, perfiles en cobre, puerta hogar y puerta horno con vidrios, revestimiento piedra serpentino.

								η		VAC					OPTIONAL	OPTIONAL SX
 CRP 90	275 kg	11,5 kW 9.890 kcal/h 80 m ² 217 m ³	-	-	14 Ø cm	12 Pa	-	77,7 %	-	-	refrattario refractory réfractaire refractorio 6 cm sp. - thk. ép. - esp. 26 cm 22 cm 51 cm		24 cm 38 cm 42 cm	-	✓	
 TCRP 90	253 kg	17,5 kW 15.050 kcal/h 127 m ² 343 m ³	9,5 kW	8 kW	14 Ø cm	12 Pa	2 bar	78,8 %	30/10 sp. - thk. ép. - esp. 20 Lt	✓	26 cm 28 cm 52 cm		24 cm 38 cm 42 cm	-	✓	

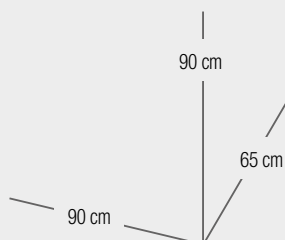

vista sopra
top view
vue de dessus
vista superior

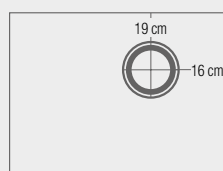

vista frontale retro
rear view
vue de derrière
vista delantera y trasera

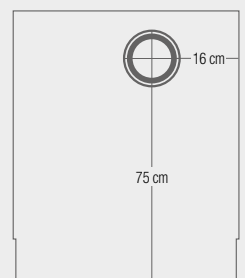

“MONTE ROSA 360”



Telai neri, profili rame e porta focolare e porta forno con vetro, rivestimento pietra serpentino.

Black door frames, copper trim, hearth door and oven door with glass, covering serpentine stone.

Châssis noirs, profils cuivre, porte foyer et porte four avec vitre, revêtement pierre serpentino.

Bastidores negros, perfiles en cobre, puerta hogar y puerta horno con vidrios, revestimiento piedra serpentino.

								η						OPTIONAL	OPTIONAL SX
 CRP 360	358 kg	11,5 kW 9.890 kcal/h 80 m ² 217 m ³	-	-	14 Ø cm	12 Pa	-	77,7 %	-	refrattario refractory réfractaire refractorio 6 cm sp. - thk. ép. - esp. 26 cm 22 cm 51 cm		26 cm 38 cm 42 cm	2,7 kW 30 cm 40 cm 45 cm	✓	
 TCRP 360	323 kg	17,5 kW 15.050 kcal/h 127 m ² 343 m ³	9,5 kW	8 kW	14 Ø cm	12 Pa	2 bar	78,8 %	30/10 sp. - thk. ép. - esp. 20 Lt	✓	26 cm 28 cm 52 cm	26 cm 38 cm 42 cm	2,7 kW 30 cm 40 cm 45 cm	✓	

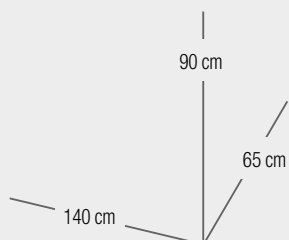

vista sopra
top view
vue de dessus
vista superior

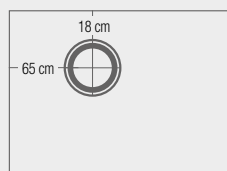

vista frontale retro
rear view
vue de derrière
vista delantera y trasera

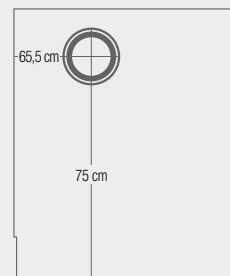







moderne



C4 - FIANCHI INOX



Con porte e fianchi inox.

With stainless steel sides and doors.

Avec portes et flancs inox.

Con puertas y lados inox.

								η		VAC					OPTIONAL	OPTIONAL SX
C4 002	163 kg	7,56 kW 6.502 kcal/h 54 m ² 146 m ³	-	-	14 Ø cm	12 Pa	-	76,24 %	-	-	refrattario refractory réfractaire refractario 3 cm sp. - thik. ép. - esp. 18 cm 35 cm 38 cm	 RAL optional	18 cm 37 cm 41 cm	-		-

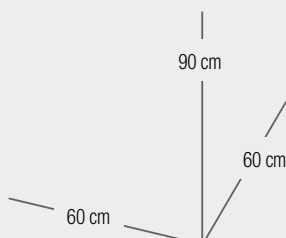

vista sopra
top view
vue de dessus
vista superior

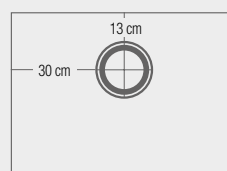

vista frontale retro
rear view
vue de derrière
vista delantera y trasera

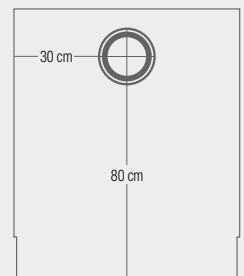

C5 - FIANCHI COLORATI



Con porte inox e fianchi neri.

With stainless steel doors and black sides.

Avec portes inox et flancs noirs.

Con puertas inox y lados negros.

								η		VAC					OPTIONAL	OPTIONAL SX
 C5 001	210 kg	9,28 kW 7.981 kcal/h 67 m ² 180 m ³	-	-	14 Ø cm	12 Pa	-	77,8 %	-	-	refrattario refractory réfractaire refractario 3 cm sp. - thk. ép. - esp. 18 cm 52 cm 38 cm	 RAL optional	18 cm 55 cm 41 cm	-	✓	-

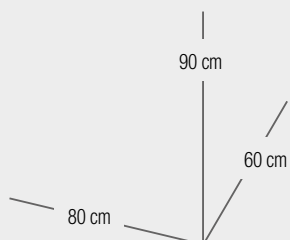

vista sopra
top view
vue de dessus
vista superior

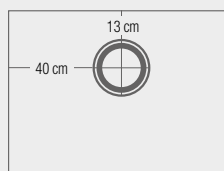

vista frontale retro
rear view
vue de derrière
vista delantera y trasera

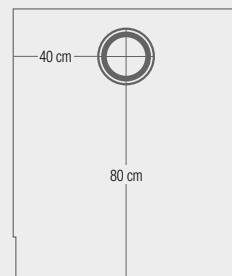





family life



GERBERA 75



								η		VAC					OPTIONAL	OPTIONAL SX
GERB75	151 kg	7,5 kW 6.450 kcal/h 52 m ² 140 m ³	-	-	14 Ø cm	12 Pa	-	76,5 %	-	-	refrattario refractory réfractaire refractorio 5 cm sp. - thk. ép. - esp. 27 cm 22 cm 34 cm	 	26 cm 22,5 cm 37 cm	-		

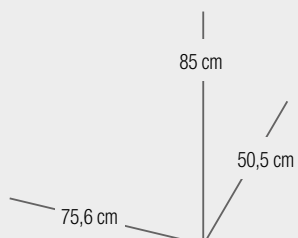

vista sopra
top view
vue de dessus
vista superior

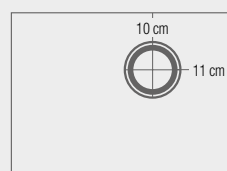

vista frontale retro
rear view
vue de derrière
vista delantera y trasera

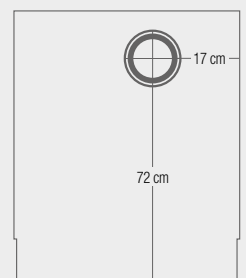

GERBERA 85



								η		VAC					OPTIONAL 	OPTIONAL SX
 GERB85	166 kg	8,5 kW 7.310 kcal/h 60 m ² 162 m ³	-	-	14 Ø cm	12 Pa	-	78 %	-	-	refrattario refractory réfractaire refractorio 5 cm sp. - thk ép. - esp. 27 cm 22 cm 38 cm	 	26 cm 30 cm 42 cm	-	✓	

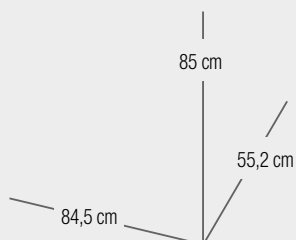

vista sopra
top view
vue de dessus
vista superior

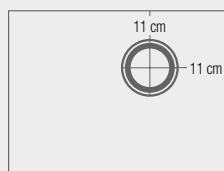

vista frontale retro
rear view
vue de derrière
vista delantera y trasera

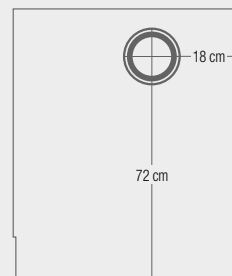

GERBERA 90



								η		VAC					OPTIONAL 	OPTIONAL SX
 GERB90	192 kg	9,5 kW 8.170 kcal/h 67 m ² 180 m ³	-	-	14 Ø cm	12 Pa	-	77,7 %	-	-	refrattario refractory réfractaire refractorio 6 cm sp. - thk. ép. - esp. 27 cm 22 cm 42 cm	 	26 cm 38 cm 42 cm	-		

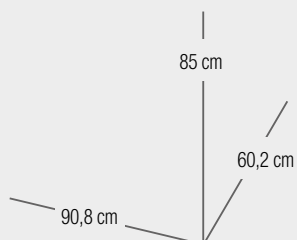

vista sopra
top view
vue de dessus
vista superior

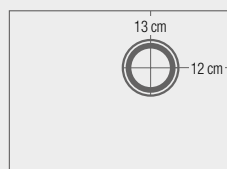

vista frontale retro
rear view
vue de derrière
vista delantera y trasera

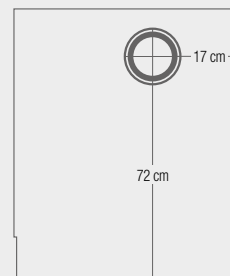

GERBERA 135



									VAC					OPTIONAL	OPTIONAL SX	
GERB135	260 kg	8,5 kW 7.310 kcal/h 60 m ² 162 m ³	-	-	14 Ø cm	12 Pa	-	78 %	-	-	refrattario refractory réfractaire refractorio 6 cm sp. - thk. ép. - esp. 27 cm 22 cm 47 cm	 	 26 cm 30 cm 42 cm	 2,7 kW 30 cm 45 cm 40 cm		

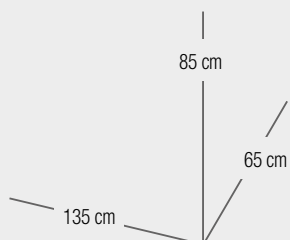

vista sopra
top view
vue de dessus
vista superior

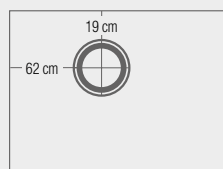

vista frontale retro
rear view
vue de derrière
vista delantera y trasera

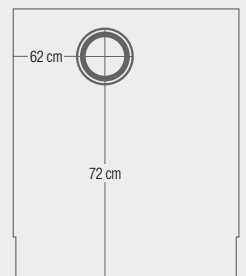



fornelli

COOKING APPLIANCES / FOURNEAUX / BRASEROS

60 GEP RUSTICA







Con fianchi piastrellati, piedi e finiture inox. Piano cottura: 4 fuochi.

With tiled sides, stainless steel feet and finishes. Cooktop: 4 burners.

Avec flancs carrelés, pieds et finitions inox. Plan de cuisson: 4 feux.

Con lados azulejados, pies y acabados inox. Placa de cocción: 4 fuegos .

CG 004	 110 kg		
	 8x8	2,7 W	30 cm 40 cm 45 cm

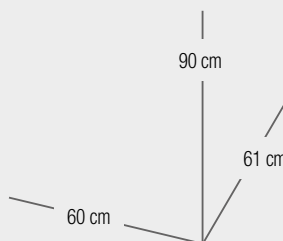

75 GS INOX "MIRTO"



**Con fianchi piastrellati e piedi.
Piano cottura: 5 fuochi.**

With tiled sides and feet.
Cooktop: 5 burners.

Avec fiancs carrelés et pieds.
Plan de cuisson: 5 feux.

Con lados azulejados y pies.
Placa de cocción: 5 fuegos.

CG 038	115 kg		
		2,7 W	
		30 cm	45 cm
		50 cm	

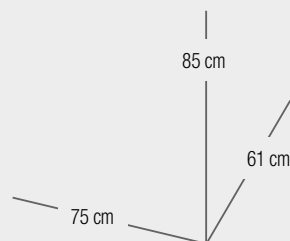

90 GEP RUSTICA



Con fianchi piastrellati, piedi e finiture inox. Piano cottura: 5 fuochi.

With tiled sides, feet and stainless steel finishes. Cooktop: 5 burners.

Avec flancs carrelés, pieds et finitions inox. Plan de cuisson: 5 feux.

Con lados azulejados, pies y acabados inox. Placa de cocción: 5 fuegos.

CG 016	132 kg		
	8x8	2,7 W	30 cm 60 cm 45 cm

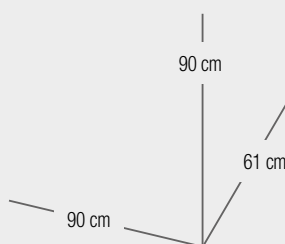

90 GEP/SF INOX



Con fianchi smaltati e piedi
Piano cottura: 5 fuochi.

With enamelled sides and feet
Cooktop: 5 burners.

Avec flancs émaillés et pieds
Plan de cuisson: 5 feux.

Con lados esmaltados y pies
Placa de cocción: 5 fuegos.

CGSF 003	129 kg	8x8	2,7 W 30 cm 60 cm 45 cm

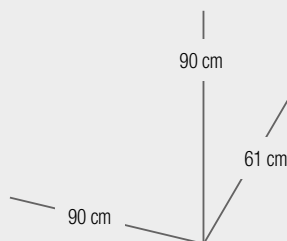

120 GEI/SF/CST INOX "MELISSA"



Con fianchi smaltati, zoccolo e carrello estraibile.
Piano cottura: 5 fuochi + 1 Domino.

With enamelled sides, base and pull-out drawer.
 Cooktop: 5 burners + 1 Domino.

Avec flancs émaillés, socle et chariot extractible.
 Plan de cuisson: 5 feux + 1 Domino.

Con lados esmaltados, zócalo y carro extraíble.
 Placa de cocción: 5 fuegos + 1 Domino.

CGSF 026	 183 kg		
	 8x8	2,7 W 30 cm 60 cm	45 cm

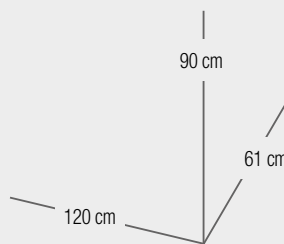

120 GEP/CST INOX "MELISSA"



Con fianchi piastrellati, piedi e carrello estraibile.
Piano cottura: 5 fuochi + 1 Domino.

With tiled sides, feet and pull out pantry drawer.
 Cooktop: 5 burners + 1 Domino.

Avec flancs carrelés, pieds et chariot extractible.
 Plan de cuisson: 5 feux + 1 Domino.

Con lados azulejados, pies y carro extraíble.
 Placa de cocción: 5 fuegos + 1 Domino.

CG 026	Kg		
	186 kg	8x8	2,7 W 30 cm 60 cm 45 cm

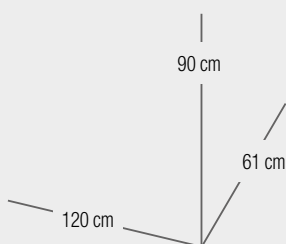





barbecue



BQ60



Barbeque a legna con griglia in acciaio inox e cassetto scaldavivande.

Wood-burning barbecue with stainless steel grill and warming drawer.

Barbecue à bois avec grill en acier inox et tiroir chauffe-plats.

Barbacoa de leña con parrilla de acero inox y cajón calentaplatos.

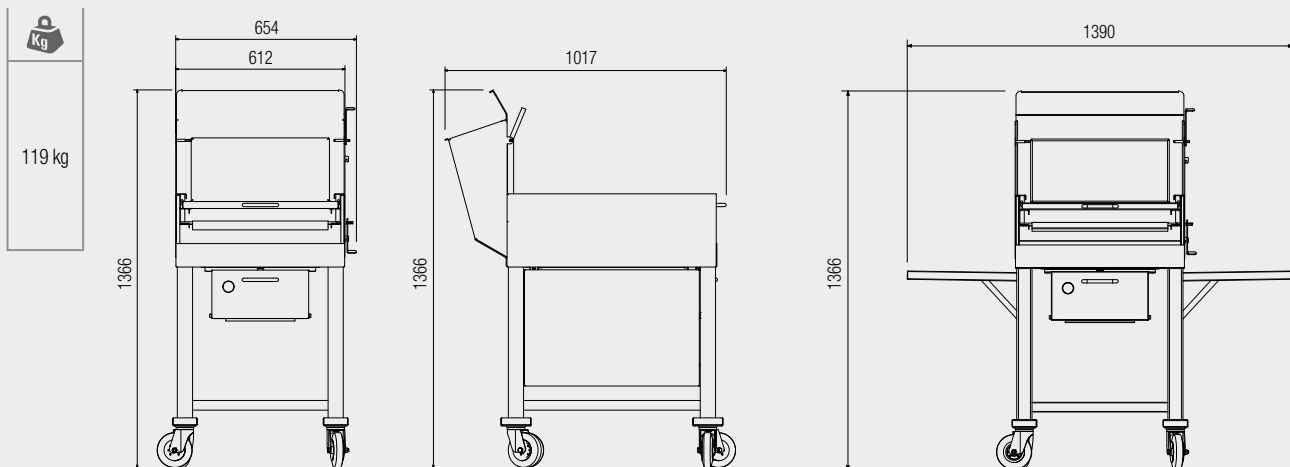

BQ100



Barbeque a legna con griglia in acciaio inox e cassetto scaldavivande.

Wood-burning barbecue with stainless steel grill and warming drawer.

Barbecue à bois avec grill en acier inox et tiroir chauffe-plats.

Barbacoa de leña con parrilla de acero inox y cajón calentaplatos.

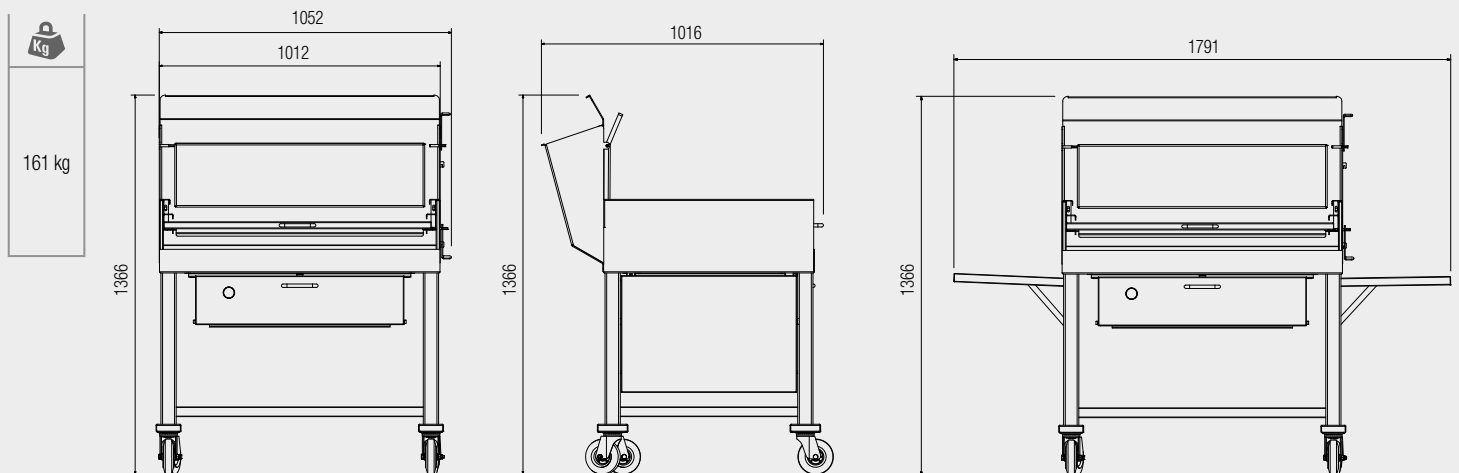





accessori e rivestimenti

ACCESSORIES AND COVERINGS / ACCESSOIRES ET REVÊTEMENTS / ACCESORIOS Y REVESTIMIENTOS

Cappe

Hood - Hotte - Campana



Interno cappa / Hood interior / Intérieur hotte / Interior Campana

Optional



Optional: colore RAL a scelta / Optional: any RAL colour
Option: couleurs RAL / Opcional: colores RAL

Standard



Cappa Piastrellata / Tiled hood
Hotte carrelée standard / Campana Azulejada Estándar

Standard



Standard: corpo cappa colore bianco o nero / Standard: white or black hood colour
Standard: corps hotte en noir ou en blanc / Estándar: Campana cuerpo en negro o blanco

Pannelli retro

Wall protection panel - Panneaux rétro - Paneles posteriores



Pannello piastrellato 10x10 / Tiled panel 10x10
Panneau carrelé 10x10 / Panel azulejado 10x10



Pannello piastrellato 8x8 / Tiled panel 8x8
Panneau carrelé 8x8 / Panel azulejado 8x8



Pannello acciaio inox / Stainless steel panel
Panneau acier inox / Panel de acero inox

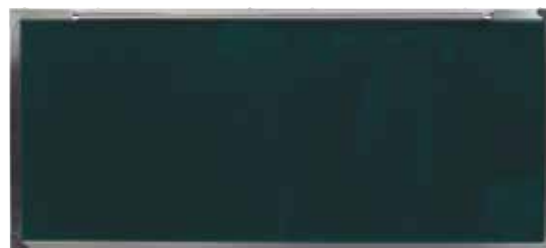

Pannello smaltato / Enamelled panel
Panneau émaillé / Panel esmaltado

Portalegna

Log stackers - Porte-bûches - Porta leña



PL 3-P8 Nero / Black / Noir / Negro



PL 2-P8 Nero / Black / Noir / Negro

Piastra

Fireproof pad - Plaques - Planchas



Piastra nera d'appoggio
Black fireproof pad
Plaque noir appui
Plancha negra de apoyo

Vaschette

Reservoir - Cuves - Cubetas



Vaschetta per acqua in ottone cromato
Chromium-plated water reservoir
Cuve pour eau laiton chromé
Cubetas para agua latón cromado



Vaschetta per acqua in ottone
Brass water reservoir
Cuve pour eau laiton
Cubetas para agua latón

Maniglie

Handles - poignées - manijas



Maniglia in Ottone RUSTICA
Rustic brass handle
Poignée laiton rustique
Manija latón rústica



Maniglia in Ottone PORCELLANA NERA
Brass and black porcelain handle
Poignée laiton porcelaine noire
Manija latón porcelana negra



Maniglia Inox PORCELLANA AVORIO
Stainless steel and ivory porcelain handle
Poignée laiton porcelaine ivoire
Manijas inox porcelana marfil



Maniglia Inox PORCELLANA BIANCA
Stainless steel and white porcelain handle
Poignée laiton porcelaine blanche
Manija inox porcelana blanca



Piastrelle per cucine 10x10

Tiles for cookers 10x10 - Carreaux pour cuisinières à bois 10x10 - Azulejos para cocinas 10x10

CD 140



CD 100 CROCCO / CD100



CD 150 2



deco CROCCO
CROCCO decoration
Décor CROCCO
CROCCO decoración

CD 190 CROCCO / CD 190



CD 120 CROCCO / CD 120



CD 150 8



CD 150 12



CILIEGIA
CHERRY
CIGLIEGIA
CHERRY
CD 150



CROCCO ARANCIO
ORANGE CROCCO
CROCCO ORANGE
CROCCO NARANJA
CD SK 07



CD 170 10



deco CAMPANELLINE
CAMPANELLINE decoration
Décor CAMPANELLINE
CAMPANAS decoración

CD 150 5



M 1 giallo chiaro



M 2 rosso matt.

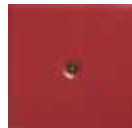

M 3 tortora



M 4 ocra



M 5 giallo



M 6 avorio



M 7 bianco



M 8 aragosta

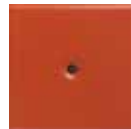

M 9 grigio fumo



M 10 azzurro



M 11 sabbia matt.



M 12 carta da zucchero



M 13 verde chiaro



M 14 verde scuro



M 15 cioccolato



Piastrelle per cucine 8x8

Tiles for cookers 8x8 - Carreaux pour cuisinières à bois 8x8 - Azulejos para cocinas 8x8

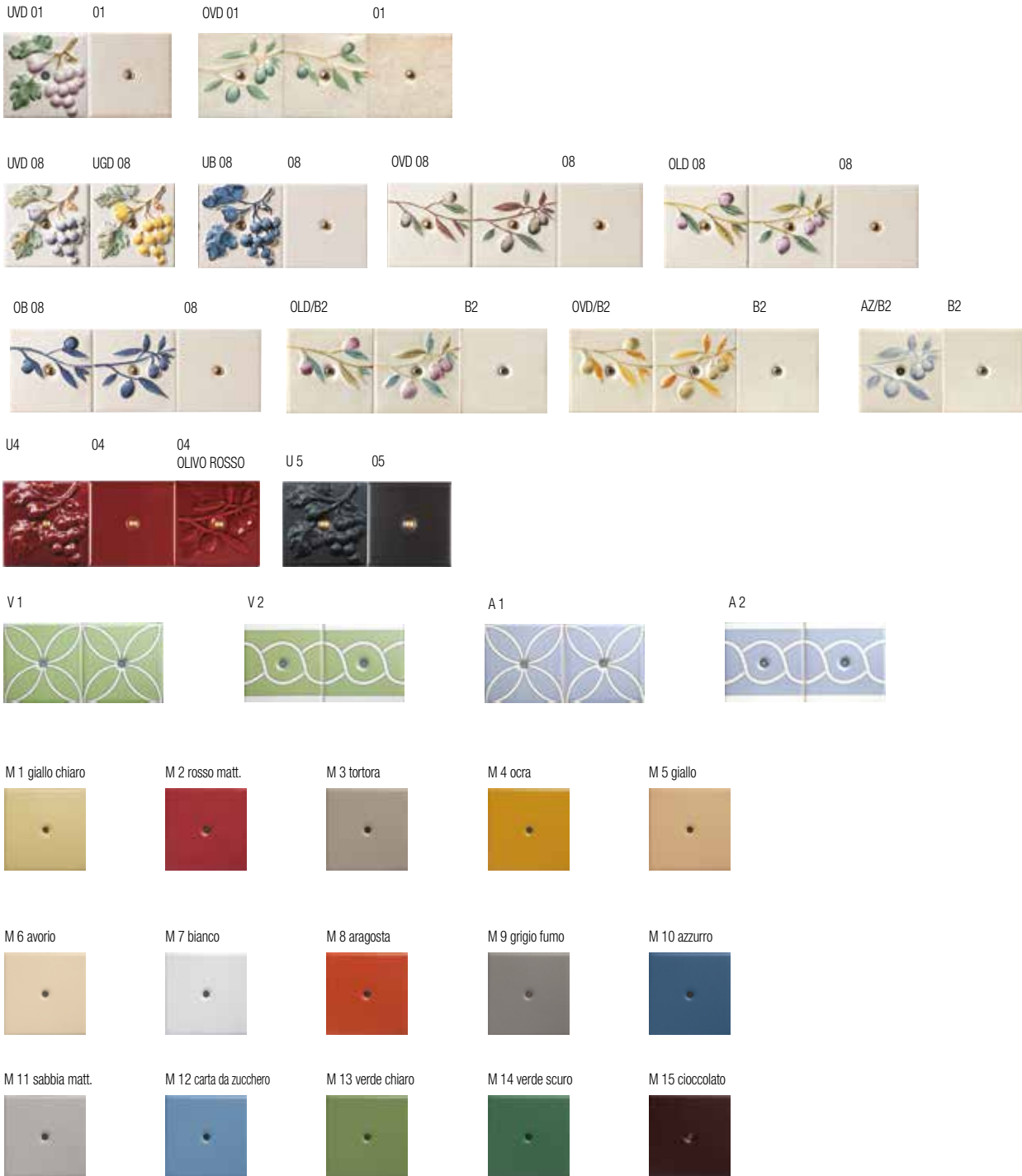

Smalti per cucine

Enamelles for cookers - Emaux pour cuisinières à bois - Esmaltes para cocinas



Decoro per smalti
Enamelles decoration
Décor pour émaux
Ornamento para esmaltes

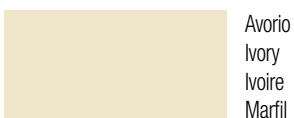

SCHEMA TIPO PER ALLACCIAMENTO CALDAIA A TERMOCUCINA A LEGNA CON IMPIANTO DI RISCALDAMENTO A VASO CHIUSO

Standard diagram for boiler connection to Thermo-cooker with sealed heating system

Schéma de principe du raccordement de la chaudière sur une Cuisinière bouilleur avec installation de chauffage à vase d'expansion fermé
Esquema modelo para la conexión caldera a Termo cocina a leña con sistema de calefacción de vaso cerrado

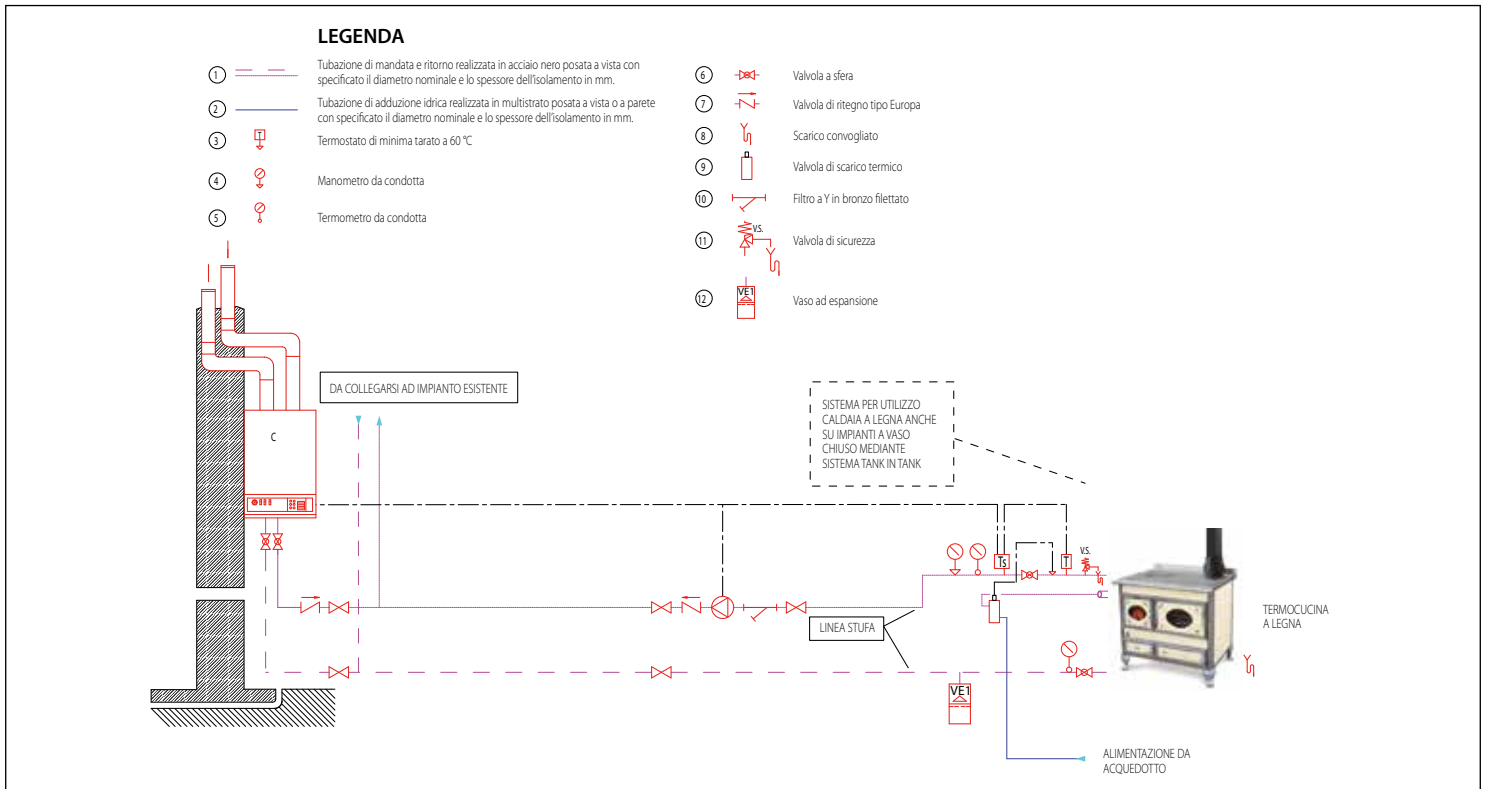

SCHEMA TIPO PER ALLACCIAMENTO CALDAIA A TERMOCUCINA A LEGNA, SERBATOIO DI ENERGIA, CON INTEGRAZIONE SOLARE, ALIMENTAZIONE IMPIANTO DI RISCALDAMENTO E SANITARIO A VASO APERTO

Standard diagram for boiler connection to Thermo-cooker, energy tank, integrated solar power system and supply line for heating and domestic hot water system with open expansion tank

Schéma de principe du raccordement de la chaudière sur une Cuisinière bouilleur à eau chaude fonctionnant au bois, avec réservoir d'énergie, intégration solaire, alimentation de l'installation de chauffage et d'eau chaude sanitaire à vase d'expansion ouvert

Esquema modelo para la conexión caldera a Termo cocina a leña, almacenamiento de energía, con integración solar, alimentación sistema de calefacción y sanitario con vaso de expansión abierto

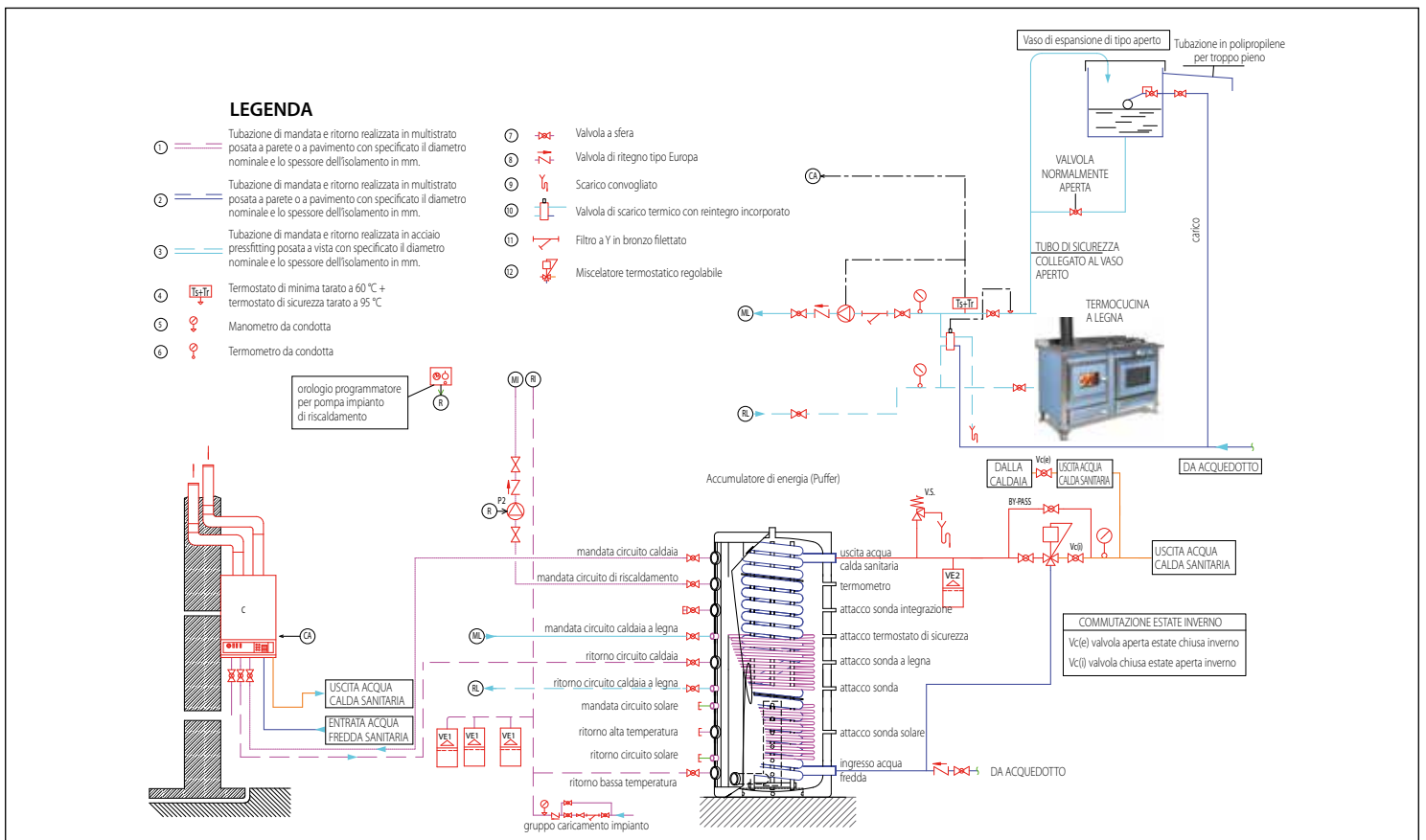



Rev. 03-09/2016

Tutti i dati tecnici sono indicativi. L'azienda costruttrice si riserva di apporre modifiche senza alcun preavviso.

All technical data are indicative. The manufacturer reserves the right to make changes without prior notice.

Toutes les données techniques sont indicatives. Le constructeur se réserve le droit d'apporter des modifications sans aucun préavis.

Todos los datos técnicos son indicativos. La empresa fabricante se reserva el derecho de hacer cambios sin preaviso.



WEKOS S.r.l.

Via dell'Industria, 18
37066 Sommacampagna (Verona)
Tel. +39 045 8960108
Fax +39 045 8960725
www.wekos.it - wekos@wekos.it